

Article number: 20652028

Description: E+G Centring bore clamp GN 411.2-30.5-K

Measures

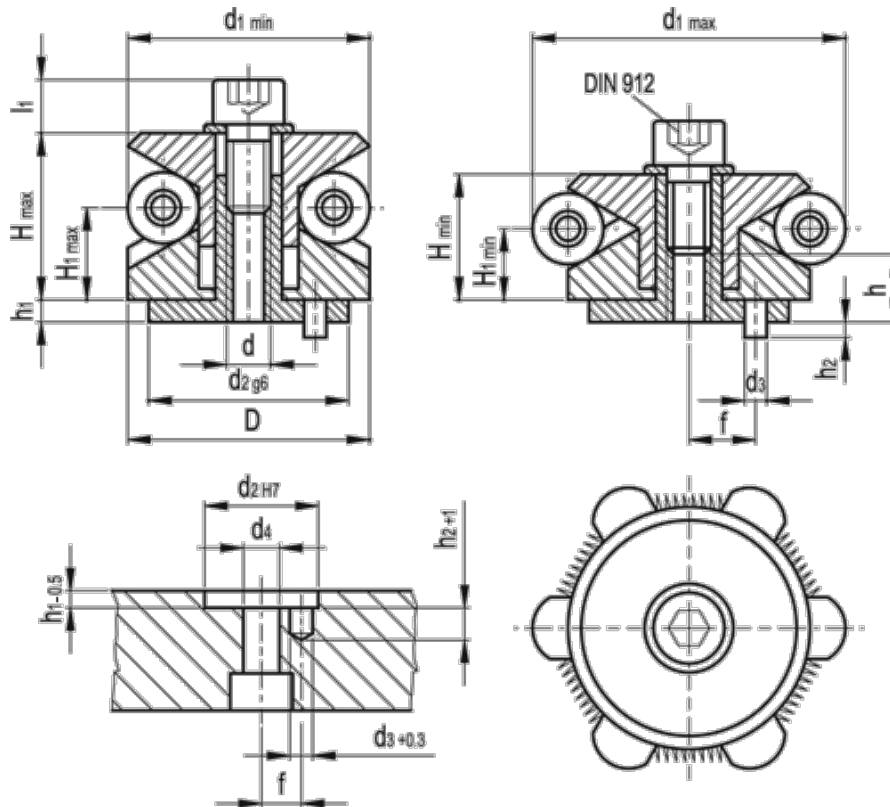

Clamping force (kN) = 5.00	d4 = 6.4	H min = 17.1
Clamping points = 3	f +/- 0.1 = 9.0	l1 = 8.8
D = 30.5	h1 = 3.5	Weight (g) = 125
d = M6	H1 max = 12.7	
d1 max = 38.5	H1 min = 10.3	
d1 min = 30.5	h2 = 4.5	
d2 g6/H7 = 25	H max = 21.7	
d3 = 4.0	h min = 9	